

構成内容 / Components				
No.	名称 / Part name	数量 / Pcs	材質 / Material	色・表面処理 / Color・Finish
1	上下カバー Top and Bottom cover	各1 1 each	アクリル板 t2.0 Acrylic t2.0	透明 Transparent
2	Wパネル W panel	2	アクリル板 t2.0 Acrylic t2.0	透明 Transparent
3	Dパネル D panel	2	アクリル板 t2.0 Acrylic t2.0	透明 Transparent
4	支柱 Extruded pillar	4	アルミ押出材 A6063S-T5 Extruded aluminium A6063S-T5	シルバーアルマイト Silver・Anodized
5	取付ビス (六角穴付皿M3 x 8) Screw (Hexagonal M3 - 8)	8	ステンレス Stainless steel	無処理 Unfinished
6	ゴム足 / Rubber feet	0 or 5	ポリウレタン / Polyurethane	透明 / Transparent

■六角レンチ付です。  
Hexagonal wrench included.

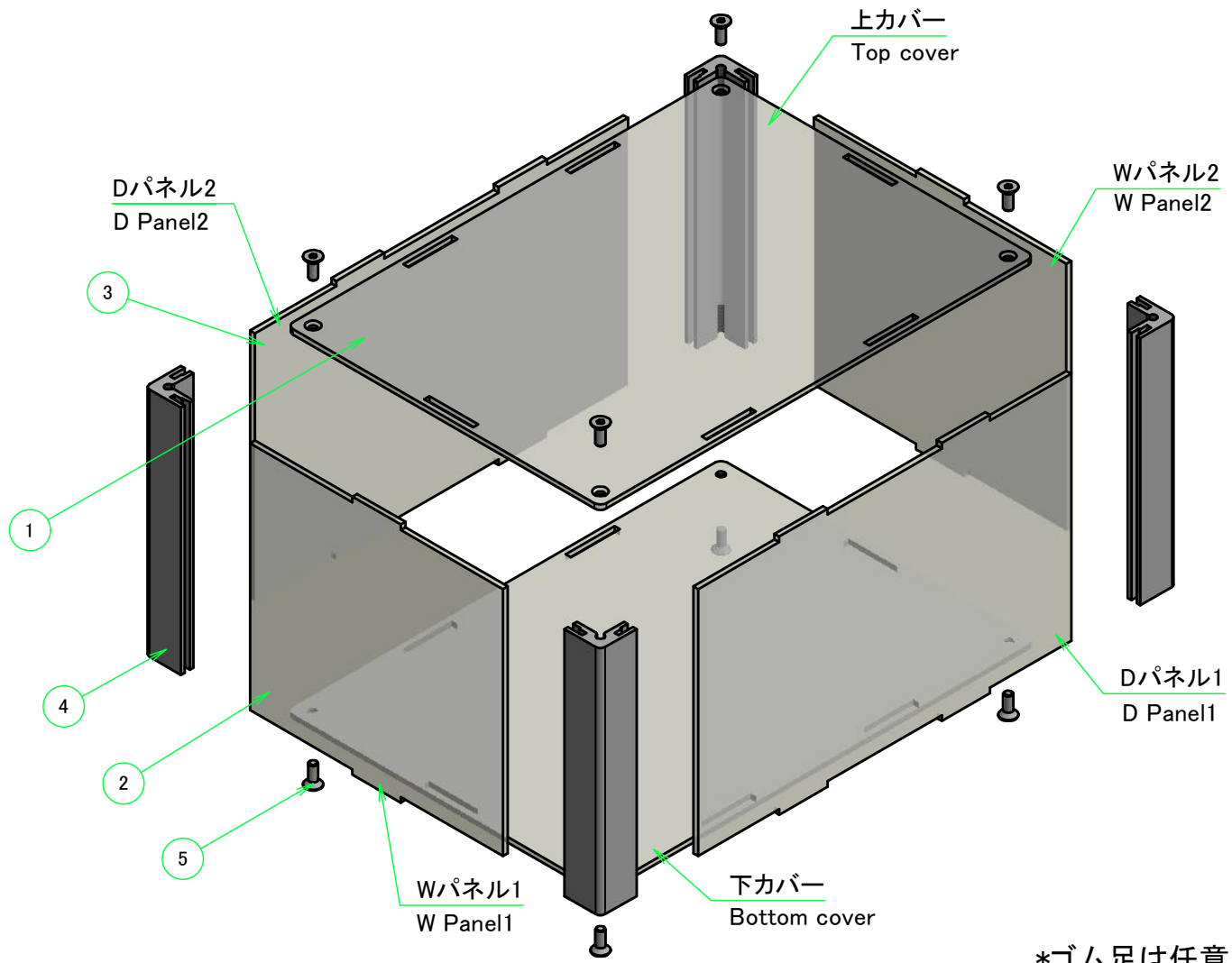

ケース型番 / Product Number

SKSF  -  -  K15   
 W H D タイプ ゴム足  
 Type Rubber feet

\*ゴム足は任意の位置に貼り付けできます。  
\*Adhesive rubber feet in cluded

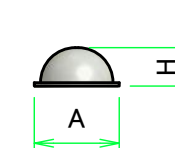

ゴム足 / Rubber feet		
記号 / Code	A	H
N (無し) / None	-	-
S	11.2	5.1
L	15.7	7.9

W・H・D 寸法制限範囲 / Dimension limit range		
W	H	D
101 ~ 150	30 ~ 500	151 ~ 200

株式会社タカチ電機工業 TAKACHI ELECTRONICS ENCLOSURE CO., LTD.			品名/Title 角型スケルトンフリーサイズケース CUSTOM SIZED ACRYLIC CASE	尺度/Scale 1 / 5
承認/Approved 中根	検図/Checked 野村	製図/Created 常山	型番/Product number SKSF□-□-□K15□ (W101~150, D151~200) 作成日/Date 2020/11/20	

外視 / External View

Wパネル2 / W Panel 2

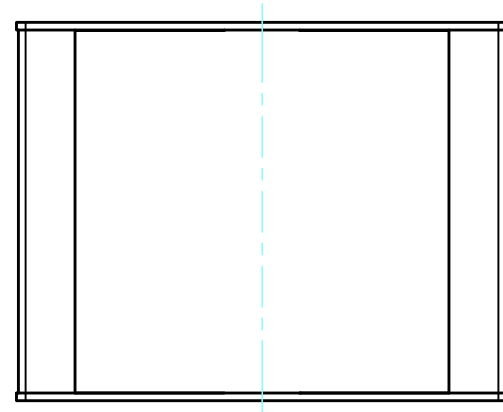

Dパネル2 / D Panel 2

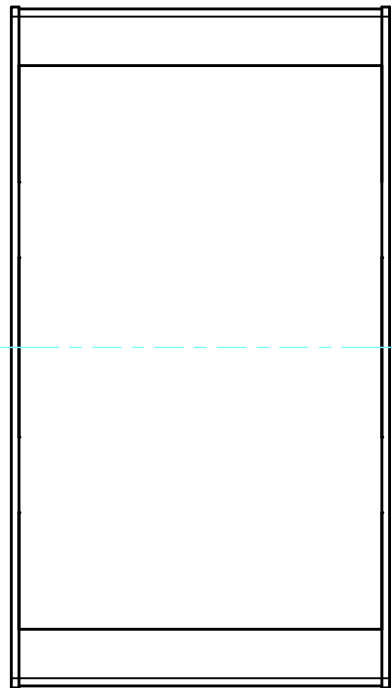

上カバー / Top cover

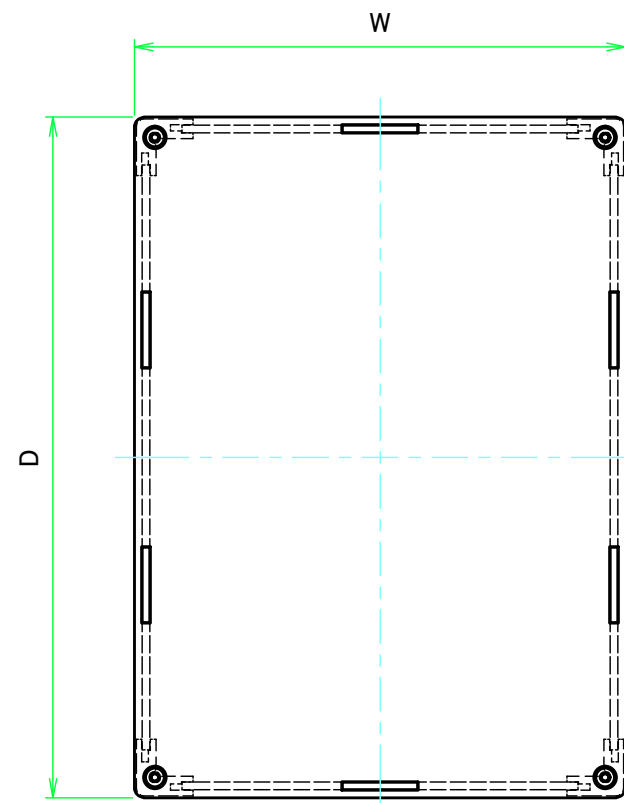

Dパネル1 / D Panel 1

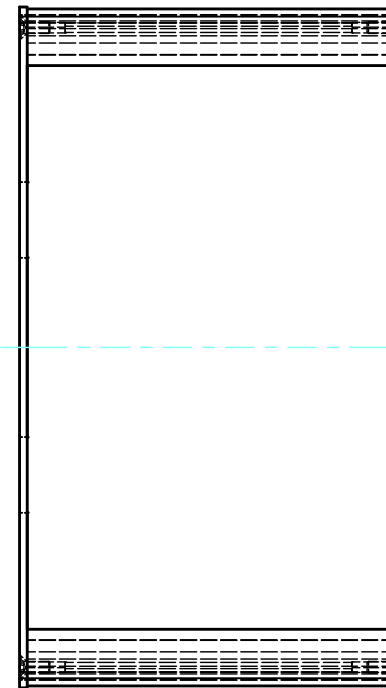

下カバー / Bottom cover

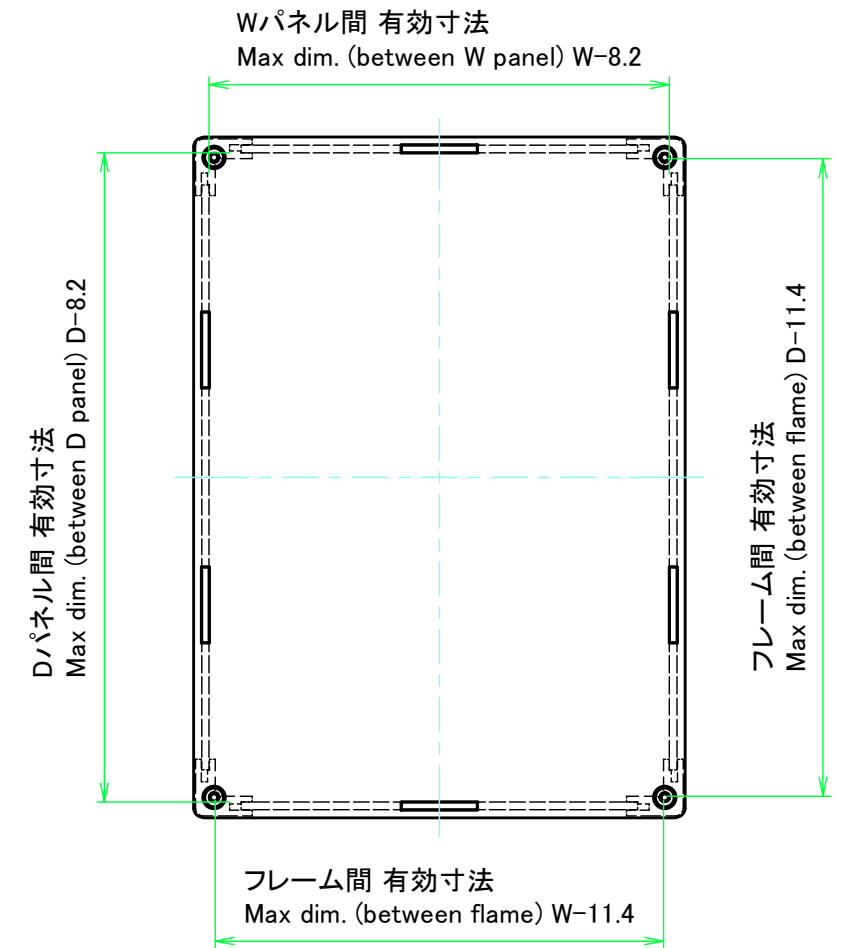

Wパネル1 / W Panel 1

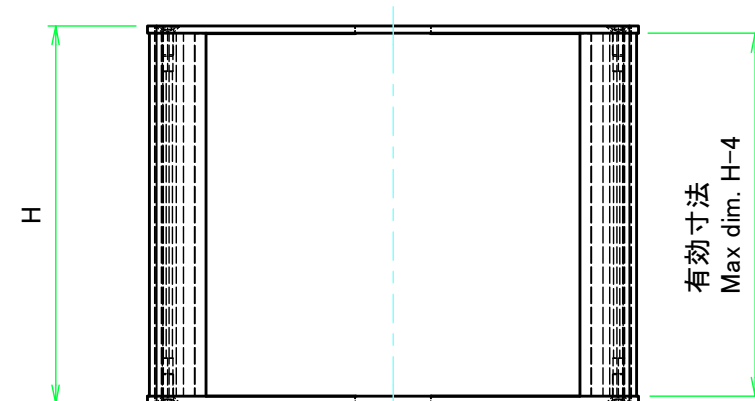

株式会社タカチ電機工業 TAKACHI ELECTRONICS ENCLOSURE CO., LTD.			品名/Title 角型スケルトンフリーサイズケース CUSTOM SIZED ACRYLIC CASE	尺度/Scale 1:2
承認/Approved	検図/Checked	製図/Created	型番/Product number SKSF□-□-□K15□ (W101~150, D151~200)	
中根	野村	常山	作成日/Date 2020/11/20	2 / 5

上下カバー / Top and Bottom cover

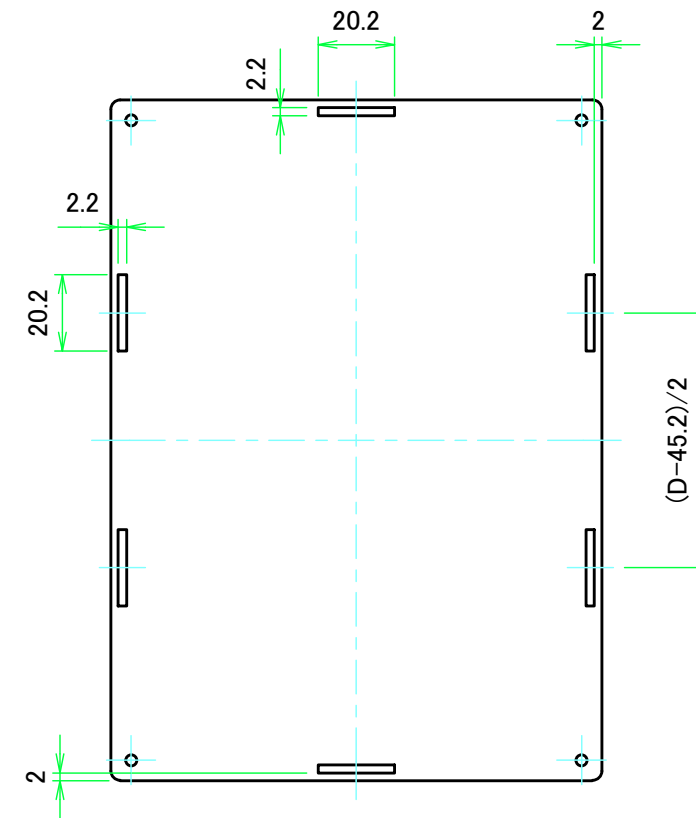
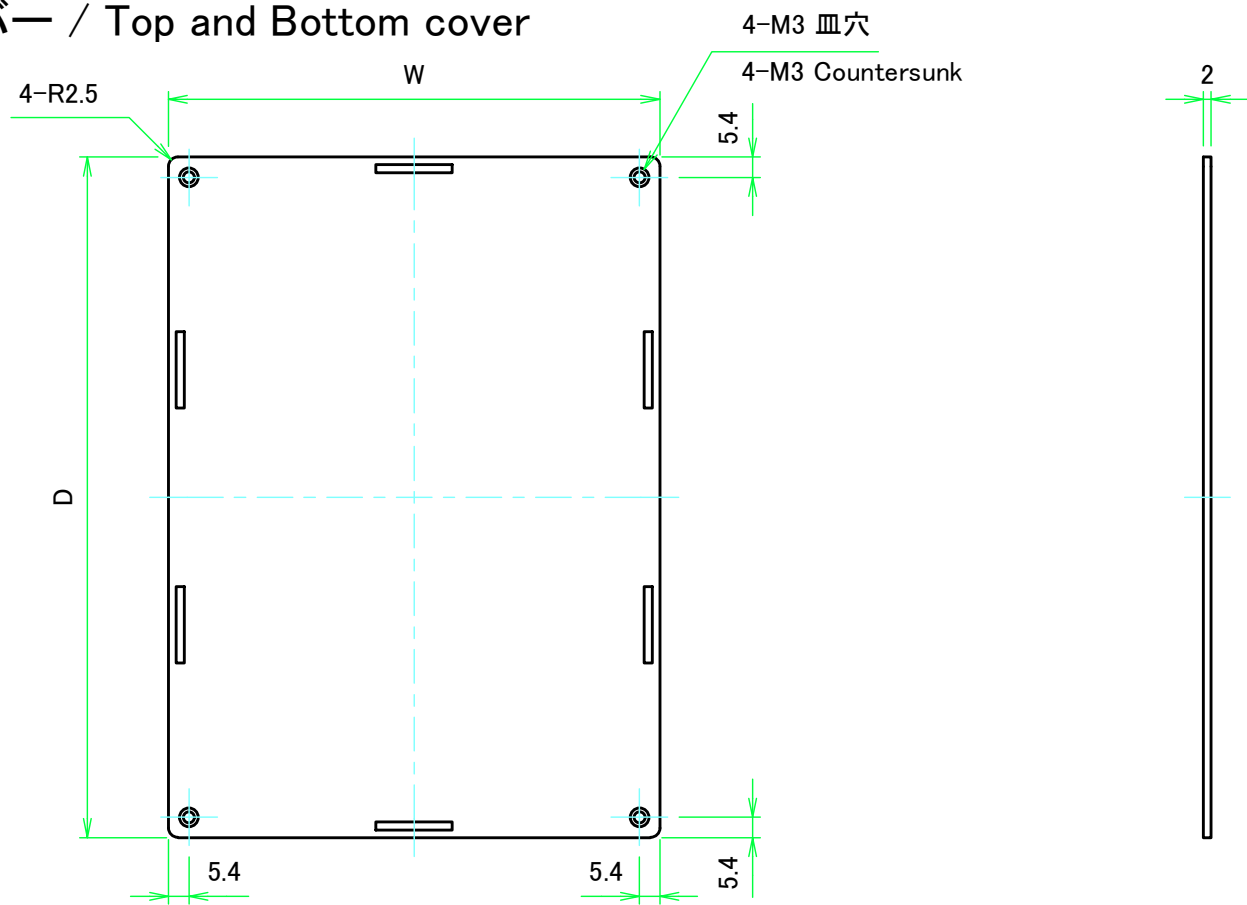

上カバー表面 / Top cover Frontside

上カバー裏面 / Top cover Backside

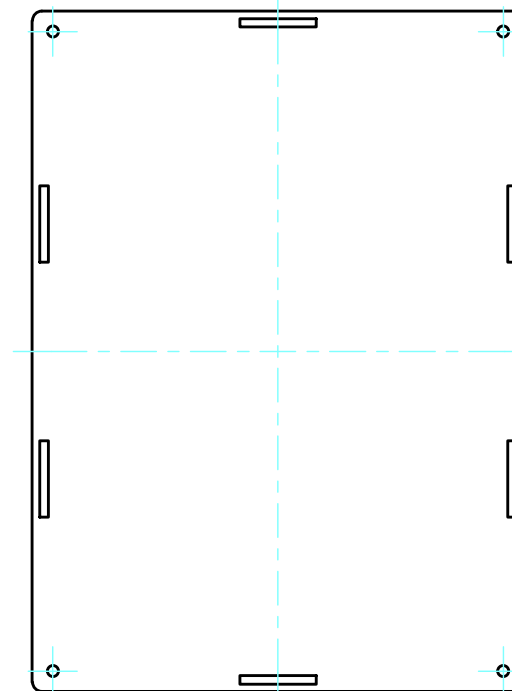
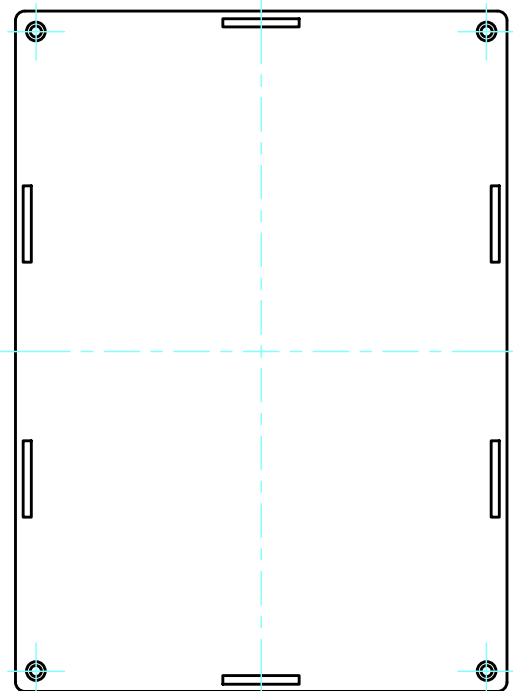

下カバー表面 / Bottom cover Frontside

下カバー裏面 / Bottom cover Backside

株式会社タカチ電機工業 TAKACHI ELECTRONICS ENCLOSURE CO., LTD.			品名/Title 角型スケルトンフリーサイズケース CUSTOM SIZED ACRYLIC CASE	尺度/Scale 1:2
承認/Approved	検図/Checked	製図/Created	型番/Product number SKSF□-□-□K15□ (W101~150, D151~200)	
中根	野村	常山	作成日/Date 2020/11/20	3 / 5

Wパネル / W Panel

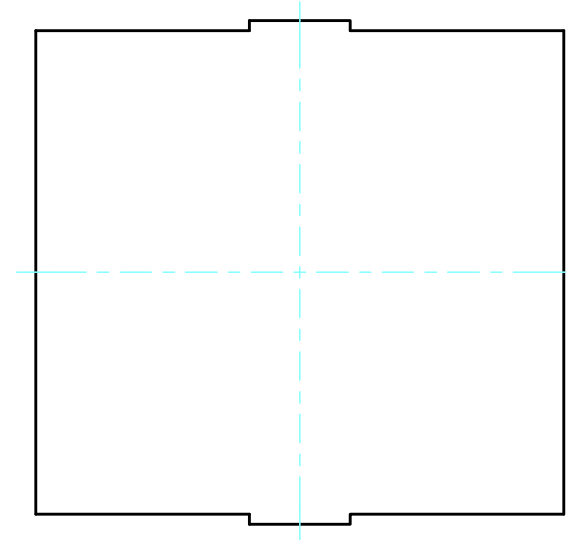
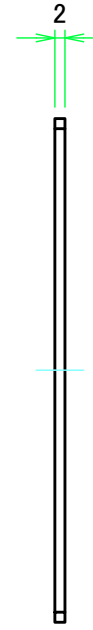
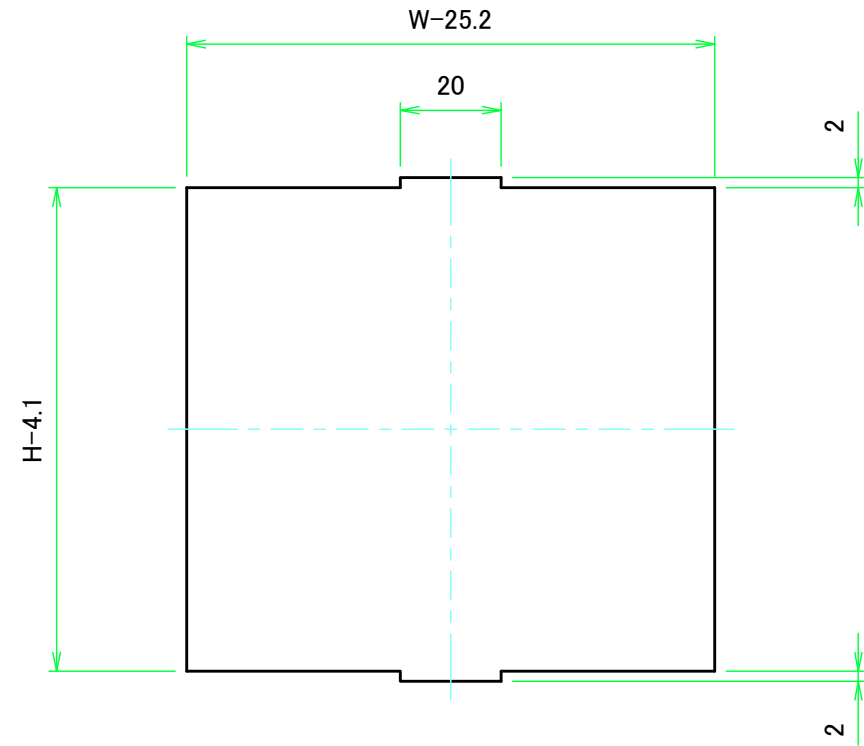

Wパネル1表面 / W Panel 1 Frontside

Wパネル1裏面 / W Panel 1 Backside

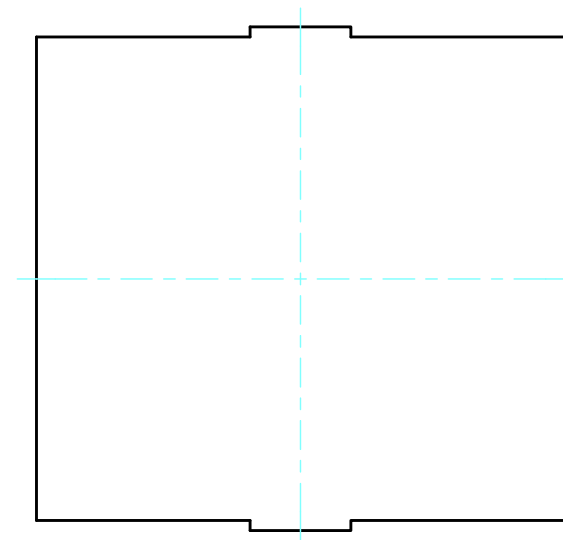
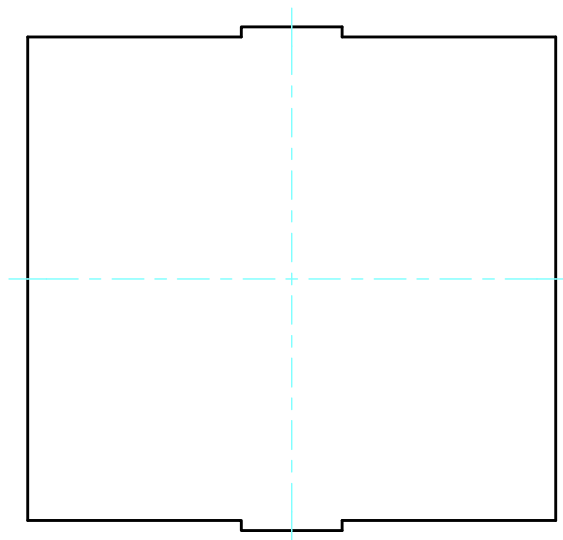

Wパネル2表面 / W Panel 2 Frontside

Wパネル2裏面 / W Panel 2 Backside

 株式会社タカチ電機工業 TAKACHI ELECTRONICS ENCLOSURE CO., LTD.			品名/Title 角型スケルトンフリーサイズケース CUSTOM SIZED ACRYLIC CASE	 尺度/Scale 1:1.5
承認/Approved	検図/Checked	製図/Created	型番/Product number SKSF□-□-□K15□ (W101~150, D151~200)	
中根	野村	常山	作成日/Date 2020/11/20	4 / 5

Dパネル / D Panel

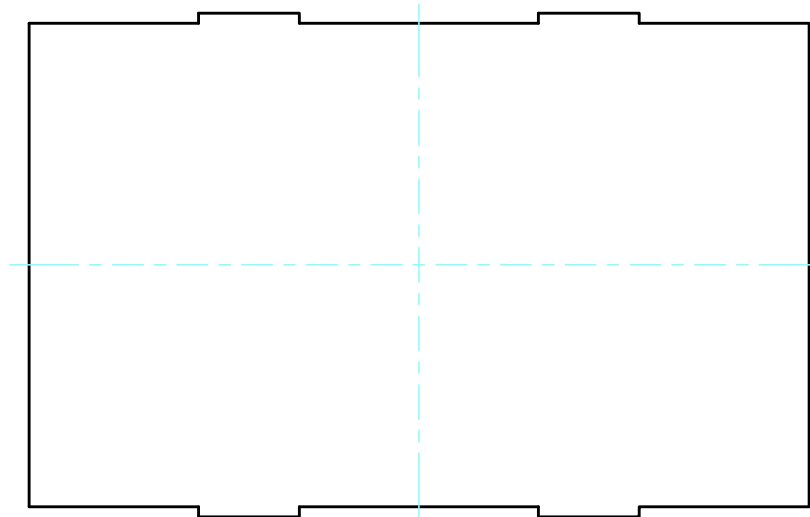
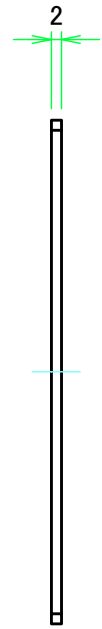
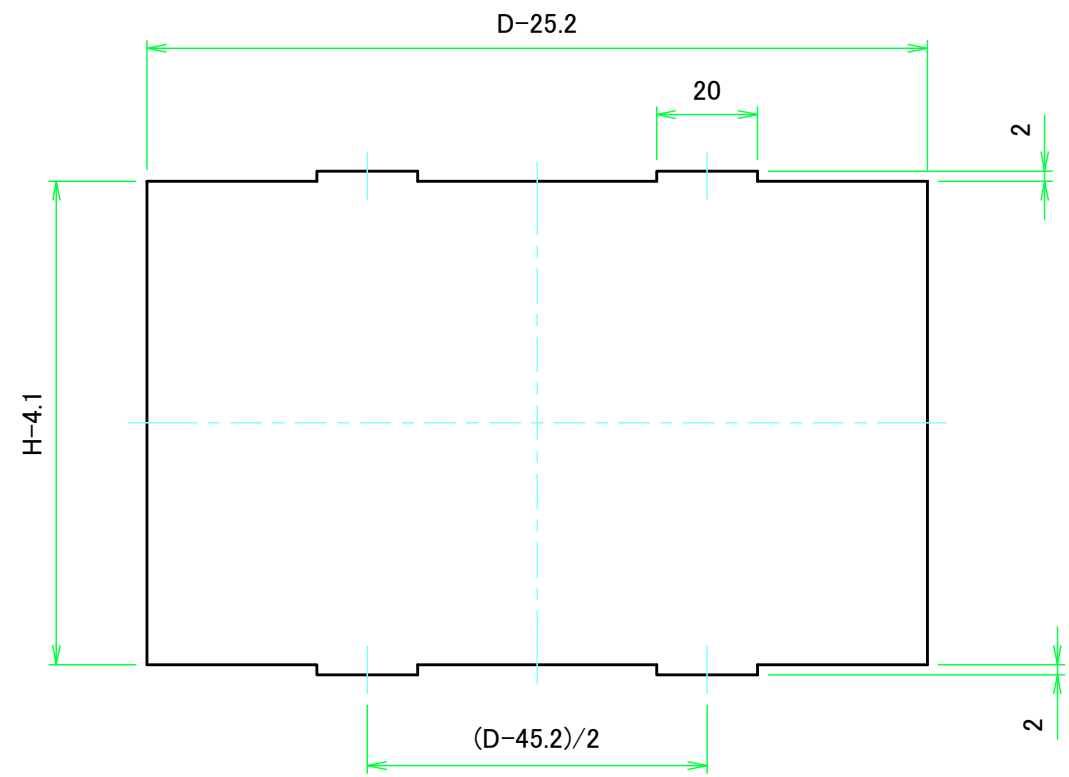

Dパネル1表面 / D Panel 1 Frontside

Dパネル1裏面 / D Panel 1 Backside

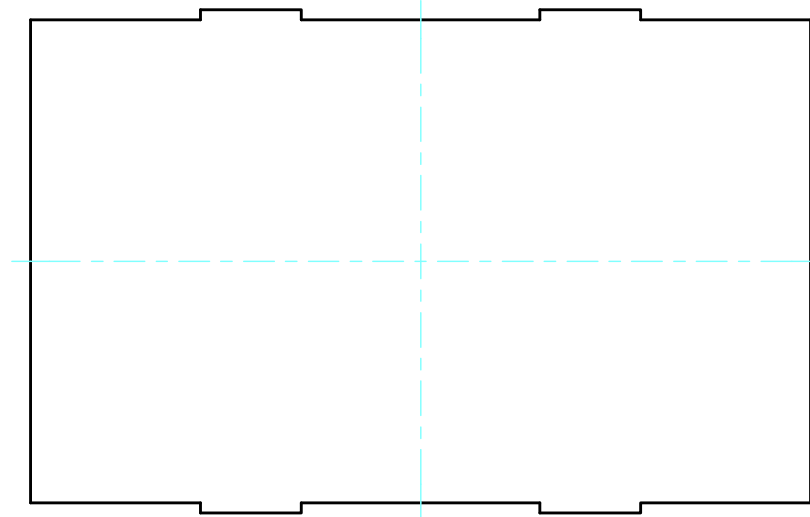
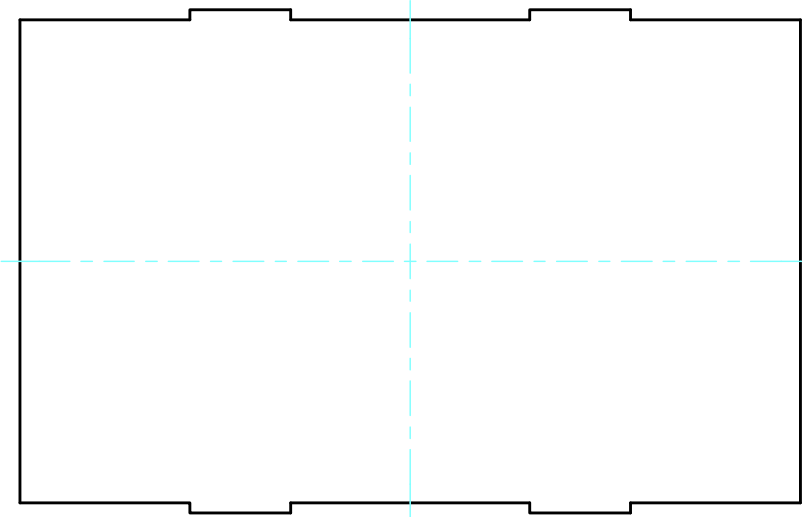

Dパネル2表面 / D Panel 2 Frontside

Dパネル2裏面 / D Panel 2 Backside

株式会社タカチ電機工業 TAKACHI ELECTRONICS ENCLOSURE CO., LTD.		品名/Title 角型スケルトンフリーサイズケース CUSTOM SIZED ACRYLIC CASE	尺度/Scale 1:1.5
承認/Approved 中根	検図/Checked 野村	製図/Created 常山	
型番/Product number SKSF□-□-□K15□ (W101~150, D151~200)			5 / 5
作成日/Date 2020/11/20			